

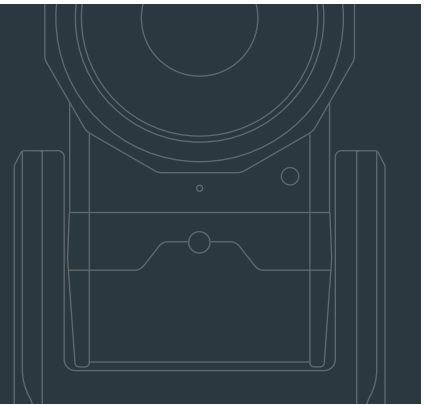

SOLOSHOT³

with Optic65 and Optic25 Cameras

User Manual



FOR OUTDOOR TRACKING ONLY unless used in conjunction with the Indoor Tracking Accessory.



Table of Contents

YOUR SOLOSHOT3	2	USING THE TRACK APP	7	MOTION TIME LAPSE (BETA)	19
In the Box	2	Begin Tracking	7	Setting MTL Parameters	19
The Tag	2	Calibrating	8	Setting Start and End Points	19
The Base and Camera	2	Tag Manager	8-9		
		Wearing the Tag	9	MANUAL APP	20
GETTING STARTED	3	Using the Track App Viewfinder	10		
Assembly	3	Using the Tag Screen	10	UPDATE APP	21
Connecting the Base to the Tripod	3	Tracking	11	Performing a Software Update	21
Charging the Base and Tag	4	Recording	11	Tag Update Mode	21
Update and Registration	4-5	Live Streaming	12		
		Moving the Base	13	SETTINGS	22
LOCATION SETUP	5	Tracking Distance	13	Wi-Fi	22
Setting up the SOLOSHOT Tripod	5			SD Card	22
Safety and Security	6	ADVANCED TRACKING SETTINGS	13	Display	22
		Track Mode	14	Battery	22
HOME SCREEN	6	Field of View	14	Date & Time	22
		Framing	14	Account	22
		Trajectory	14	About	22
				Help	22
		CAMERA SETTINGS	15	Developer Options	22
		Access Camera Settings	15		
		Video Mode	15	HDMI OUT	23
		Photo Mode	16		
		Taking Photos	16	AUDIO	23
		MULTI MODE	17	HOT SHOE MOUNT	23
		Requirements	17		
		Filming Multiple TAGS	17	MAINTENANCE	23
		from a Single BASE			
		Filming a single TAG	18	OFFLOADING CONTENT	24
		from Multiple BASES (Angles)			
		Filming Multiple TAGS	18		
		from Multiple BASES			



Your SOLOSHOT3

In the Box

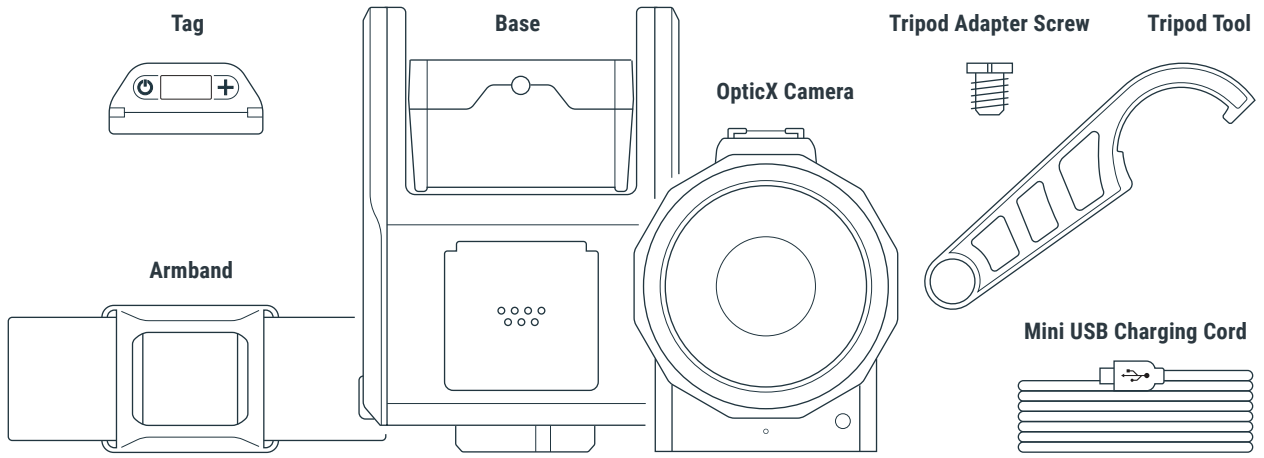

The Tag

- 1 Power Button
- 2 OLED Screen
- 3 Function Button

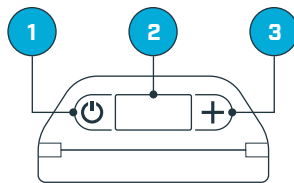

The Base & OpticX Camera

- 1 Hot Shoe
- 2 Mono Mic
- 3 3.5 mm Auxiliary Jack
- 4 Indicator LED
- 5 K-Lock Slot
- 6 Accessory Port/Tag Charger
- 7 Mini USB Charging Port + USB Type A Port
- 8 HDMI Out
- 9 Micro SD Card Slot
- 10 Camera Release Button
- 11 Power Button
- 12 Touchscreen
- 13 3/8" Tripod Mounting Head

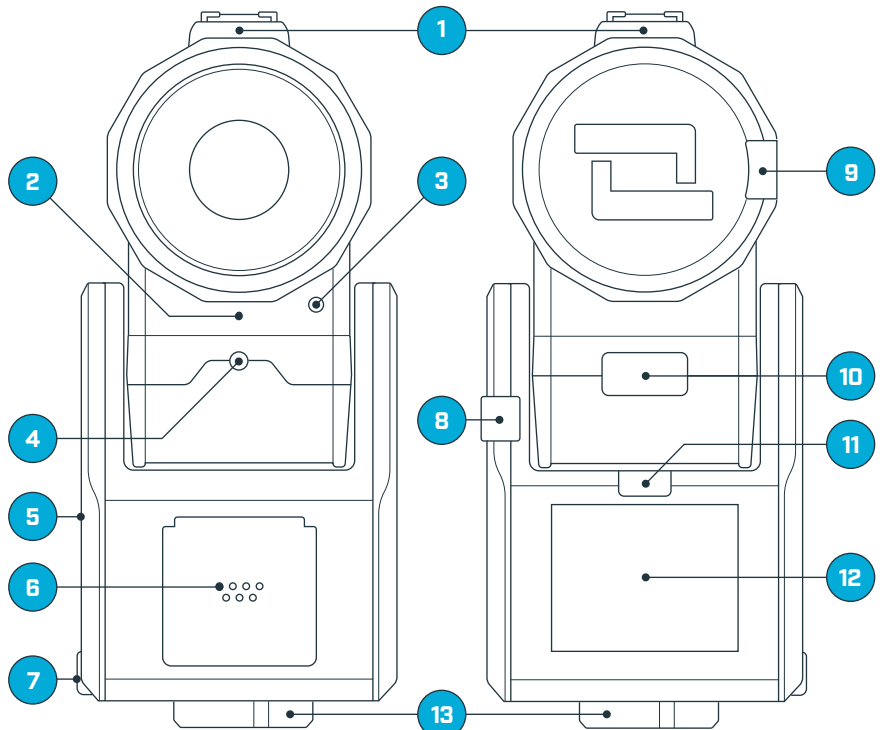



Getting Started

Assembly

1 Docking the Tag

Dock the **Tag**, with buttons facing up, into the **Accessory/Charging Port** on the front of the **Base**.

Attach the Tag to the Base by first inserting from the top, as depicted in the graphic below.

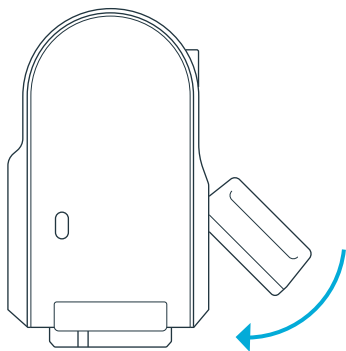

2 Docking the Camera

Dock the **OpticX Camera** to the **Base** by guiding it down onto the tilt drum from above, and then pushing it forward until it securely clicks into place.

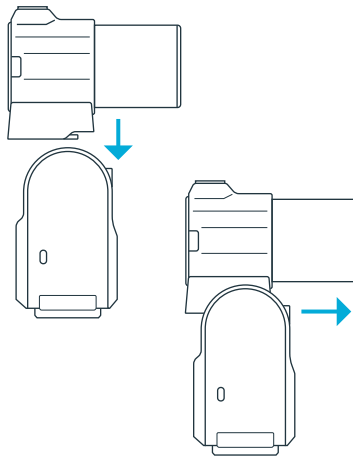

3 Micro SD Card

Insert an approved **Micro SD Card** (not included) into the side of the OpticX Camera. You will hear a click when fully inserted.

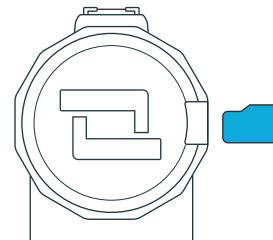

IMPORTANT

Your SD card will be completely erased. Make sure to save any content that you don't want erased!

Visit support.soloshot.com for a list of compatible SD cards.

Connecting the Base to the Tripod

1 Tripod Adapter Screw

For the best results, we recommend mounting the **Base** on a **Tripod** with a **3/8"** mounting screw.

If you already have a pan/tilt head on your tripod, please remove it prior to connecting your Base.

If your tripod only has a **1/4"** screw, use the provided **Tripod Adapter Screw**.

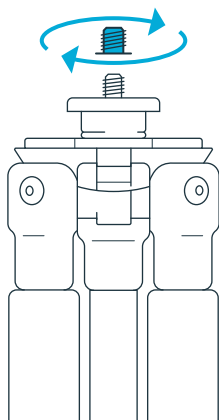

2 Connecting

Hand tighten the Base onto your tripod until you feel light resistance from the panning motor. **Avoid excessive manual panning and tilting of the Base motors by hand.**

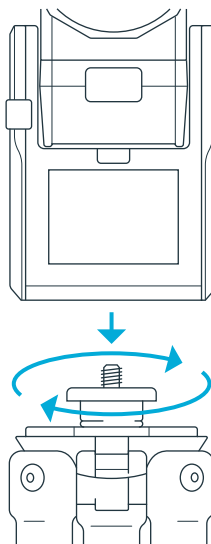

3 Using the Tripod Tool

Use the provided **Tripod Tool** to finish tightening.

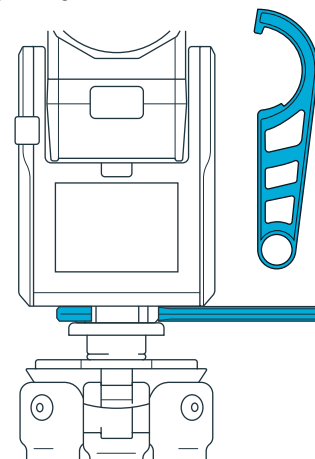

IMPORTANT

For the best experience, use a sturdy tripod. Visit soloshot.com to purchase a recommended tripod.

Charging the Base and Tag

1 Charging Cord & Adapter

Insert the **Mini USB Charging Cord** into a USB outlet adapter (not included) and plug it into the **Base**.

1.5A to 2.1A outlet adapter is required. (most tablet charger adapters)

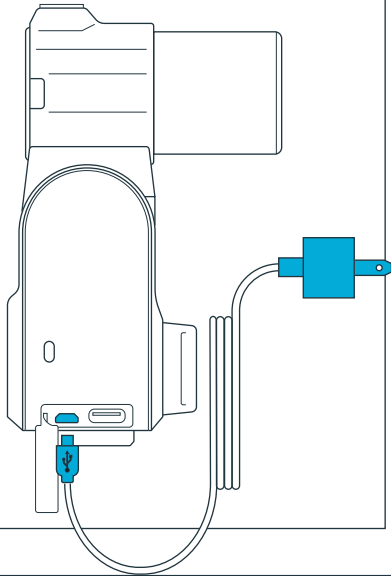

2 Charging Time

Fully charge the **Base** and **Tag** prior to use. This will take about 4 hours. Charging time varies based on USB wall adapter rating.

i INFO

Only the Base & Tag contain batteries and must be recharged. The Camera can, but does not need to be connected.

! IMPORTANT

The SOLOSHOT3 must be in an upright position during device update & registration, and during general use.

Prevent SOLOSHOT3 from tipping over when the Camera is connected.

Connect the Base to your Tripod. (See page 3)

3 Powering On

To power on Base, press and hold the Power Button for 3 seconds.

To power on Tag, press the Power Button.

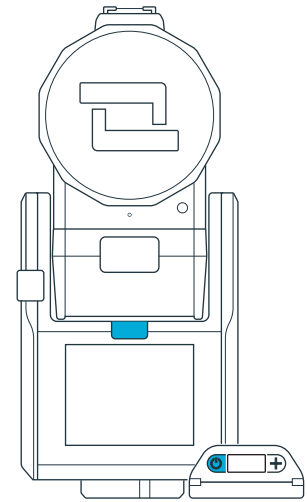

Update and Registration

1 Create an Account

Create a SOLOSHOT account at app.soloshot.com.

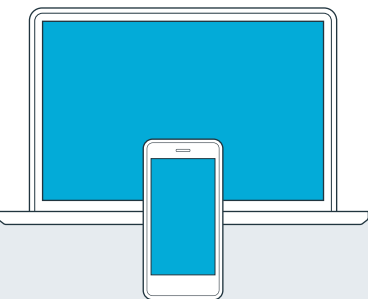

! IMPORTANT

A SOLOSHOT account is required before setup of your SOLOSHOT3.

2 Update

Power on the Base and follow the on-screen instructions to update your device.

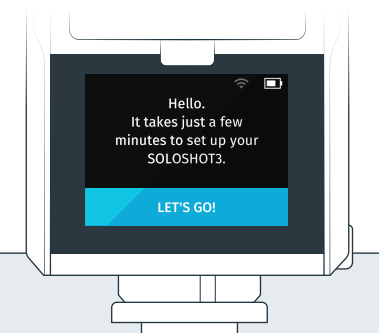

! IMPORTANT

Your SOLOSHOT3 must be upright and level upon start-up and updating software.

It's recommend it be connected to a tripod during this process.

3 Tag Registration

After registering your Tags, you are prompted to select the tracking preferences of the Tag.

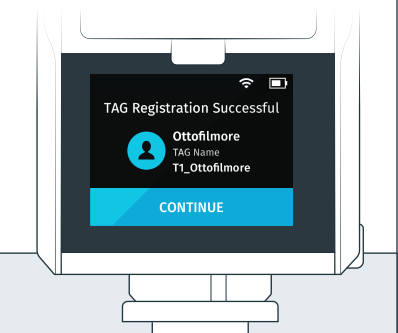

! IMPORTANT

The screen will be blank for up to one minute during certain steps of the update process.

Do not power down device during update.

i **Tag Preference: Auto Track**

When the Tag is turned on and within range of the Base, the Base will automatically track this Tag.

This is the default setting.

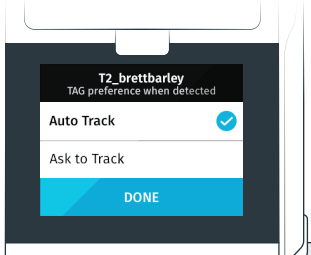

i **Tag Preference: Ask To Track**

When the Tag is turned on and within range of the Base, the Tag will need to be toggled on within the **Tag Manager**.

Tags that are toggled off will not be tracked by the Base.

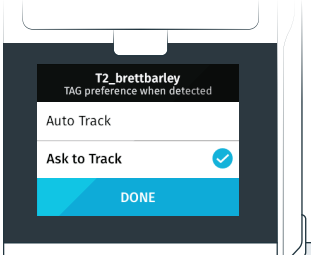

4 **Registration**

Finish setup by updating and registering your Base, Tag(s) and Camera to your SOLOSHOT account, created in Step 1.

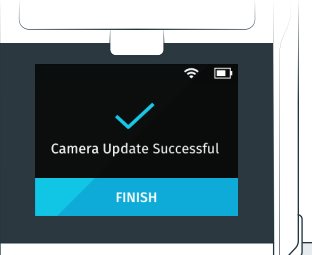

! **IMPORTANT**

To ensure the best filming results:

- Level your SOLOSHOT3 using the bubble level on the Tripod.
- Ensure that both the Base and Tag always have a clear view of the sky.
- Do not bring the Tag and/or Base inside once powered on.
- Do not setup under an overhang, dense tree canopy, or close to a building or cliffs.

i **Setting up the SOLOSHOT Tripod**

Open and set up the **Tripod** by unlocking the **Leg Locks (a)** and extending the telescoping legs until the Tripod is at the desired height.

Lock the Leg Locks.

In windy or otherwise unstable conditions, be sure to widen the leg stance using the **Wide Leg Locks (b)**.

Tripod Neck Extension:
Extend the Tripod Neck by loosening the **Neck Thumb Screw (c)**. Tighten Neck Thumb Screw and Leg Locks when desired height is achieved.

Wide Leg Lock Option:
Use a wider stance if necessary to improve stability or to account for local topography. For example, in windy or unstable conditions, or in areas where the Tripod may be bumped or jostled, you should use a wider stance.

Windy Conditions:
Add a weight to the hook on the bottom of the Tripod neck and/or widen the leg stance, as outlined above.

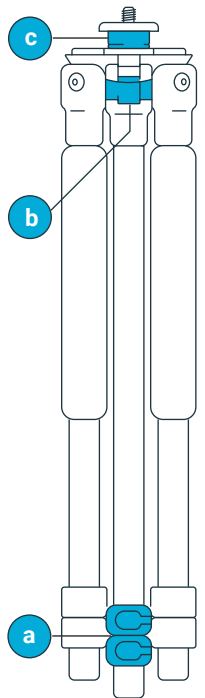

Safety and Security

1 Location

Make sure the location you choose for your SOLOSHOT3 is safe and secure.

Be smart and creative when selecting your setup location and leaving your Base and Camera unattended.

2 K-Lock

Use the k-lock accessory to secure the Camera to the Base.

Available at soloshot.com.

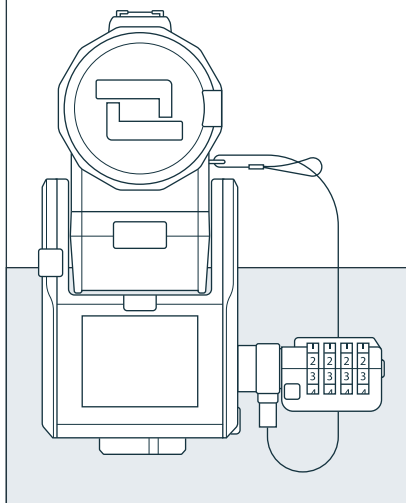

! IMPORTANT

SOLOSHOT Inc. **IS NOT** responsible for theft or damage to your SOLOSHOT3 and it's accessories.

Avoid using SOLOSHOT3 near high voltage power lines, radar/radio jamming equipment, or telecommunications towers, as this could interfere with the communication system.

Home Screen

i Page 1

Manual Control: Record or live stream without enabling automatic tracking.

Track: Start/stop tracking, toggle record on/off, trigger single photos or bursts, adjust tracking and camera settings, quickly manage your Tag(s), and live stream.

Time Lapse: Capture a series of photos at preselected intervals. [Coming Soon]



i Page 2

Tags: Select Tags that you would like to track from the Tag Manager.

Settings: Manage Wi-Fi, format the SD card, access current software version and more.

Update: Install the most recent software updates on the Base, Tag and/or Camera. When updates are available, the user will be notified upon entering the Update App.

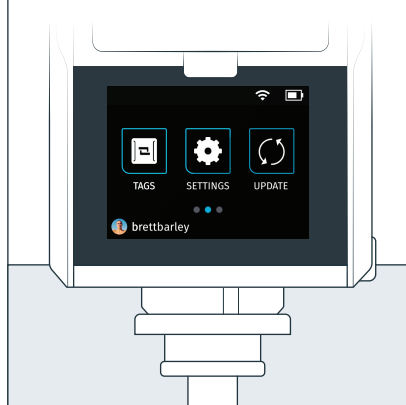

i Avatar and Username

Gallery: Playback your video and photos on the touchscreen. [Coming Soon]

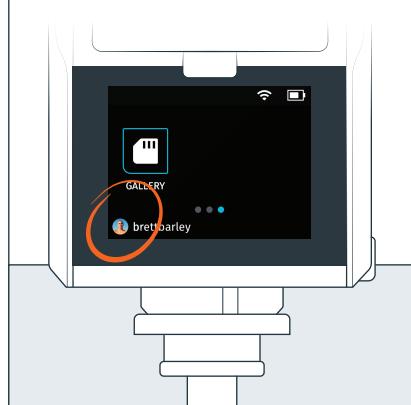

Begin Tracking

1 Home Screen/Track App

Within the HOME SCREEN, tap TRACK to enter the Track App.



2 Track Button

Tap the TRACK button.

- If "Ask to Track" was selected when setting up your Tag or no Tag is detected, follow the onscreen instructions.

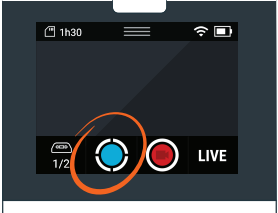

3 Tracking Action Sheet

This is the tracking action sheet, which allows you to either begin tracking, or change tracking settings.

Select TRACK.

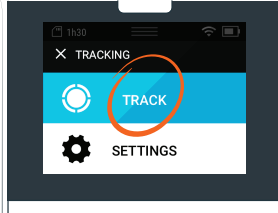

4 Track Modes

Select the TRACK MODE that best matches your activity.

See page 14, Track Mode descriptions

Tap CONTINUE to begin calibrating the system.

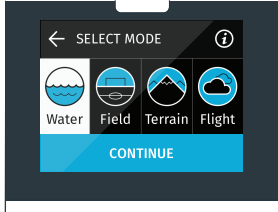

5 Calibration

The Base and Camera will spin and tilt for about one minute as it calibrates the sensors.

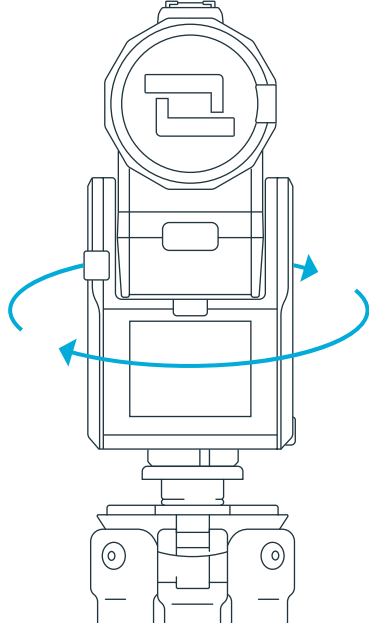

! IMPORTANT

Before beginning your activity, we recommend that you walk back and forth in front of the Camera a few times in the area where you will be performing your activity. This will allow the Camera's smart tracking system to center you in the screen.

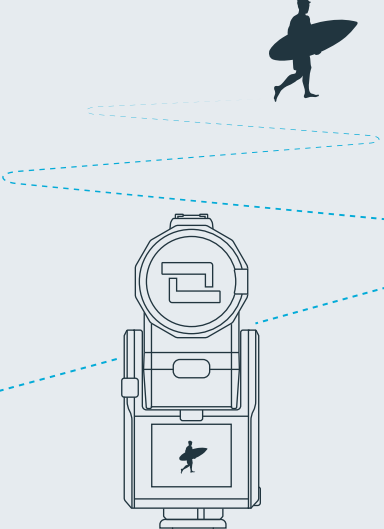

Calibrating



Successful Calibration

Once calibration is successful, your Base will automatically begin tracking the selected Tag(s).

Other successful calibration indicators:

- The Camera viewfinder appears on the screen.
- The LED at the front of the BASE blinks green.

If every selected Tag indicates they do not wish to be tracked, then the Base will be idle.



IMPORTANT

SOLOSHOT3 is designed to track subjects outside a 10 ft. radius.

If the subject is inside this radius, tracking may not work properly.



Problem Detected

Calibration may fail due to poor GPS signal or local magnetic interference. In this case, follow the on-screen instructions.

Please be sure to set up your Base in a location with a clear view of the sky and away from sources of magnetic interference.

See page 5, LOCATION SETUP



Green Indicator LED States

LED is highly directional and changes brightness with distance. If you can see it, the Base is pointing at you and you are within range.

Slow Blinking

Base is actively tracking. No problems detected.

Rapid blinking or No blink

Problem detected. Return to the Base immediately and resolve the issue via on-screen instructions.

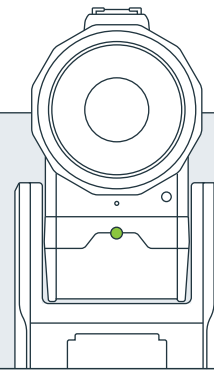

Tag Manager

Continue on next page



REQUIREMENTS

In order for a Tag to be detected by a Base, it must be:

- Powered on
- Have been docked to the Base in the past
- Be within the 2,000-ft. tracking distance
- Have a GPS signal

1

Accessing the Tag Manager

The TAG MANAGER is accessible in the following ways.

Home Screen (below)

Track App (See page 9)

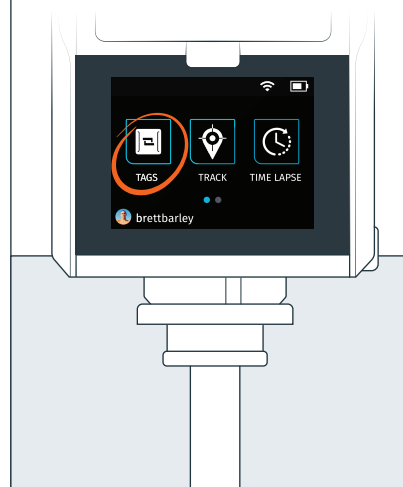

2

Selecting Tags

Select the Tags you want to Track or pair new Tags by docking them to the accessory port on the front of the Base.

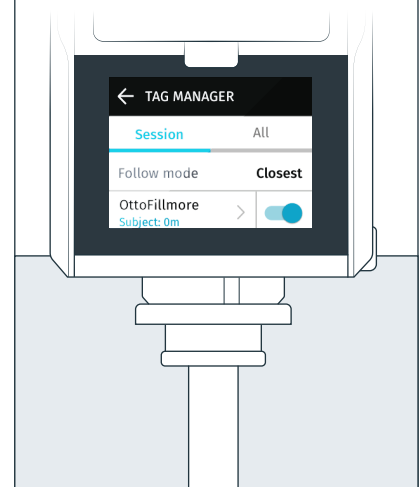

3 Tag Icon to Tag Manager

Tapping the **Tag Icon** will take you to the Tag Manager.

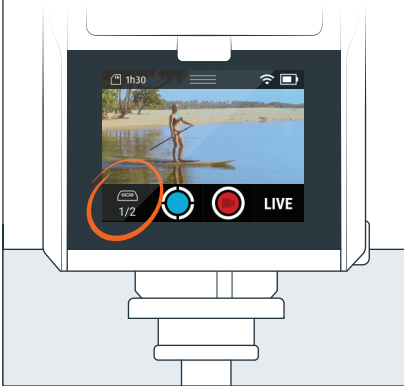

i The Numbers

Below the Tag Icon are two numbers.
 The numerator (1st number) shows how many Tags are currently being tracked.
 The denominator (2nd number) shows how many Tags are paired, in range, and available to be tracked.

i Tag Manager: Session

This list comprises of Tags that the Base is currently tracking, meets the pre-requisites to be tracked, or has been tracked in the current session.

The list starts out empty until a Tag meets the pre-requisites. Tags remain in the list until the Base has been turned off, but will remain in the ALL list.

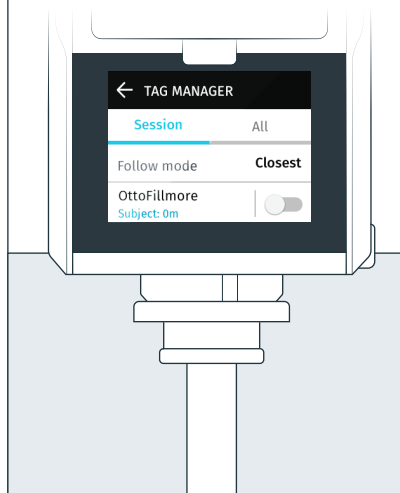

i Tag Manager: All

This list shows a history of every Tag that has ever been docked onto the Base, even if they do not meet the pre-requisites.

This allows you to view and manage your history of Tag, including the ability to forget Tags.

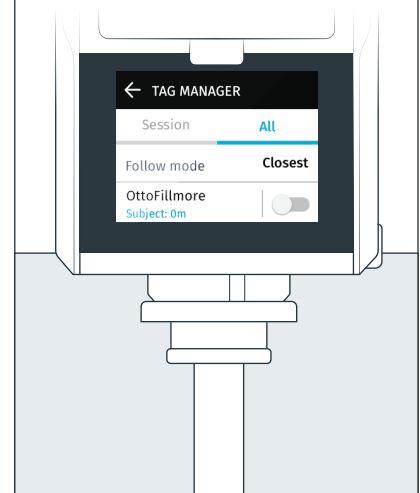

Wearing the Tag

1 Snapping In

Snap the **Tag** into the **Armband Clip** with the button side aligned with the clip window.

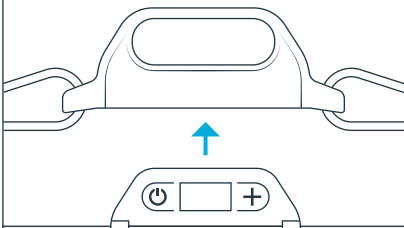

2 Hear the "Click"

You will hear a distinct click when Tag is in place.
 Check the alignment and adjust if necessary.

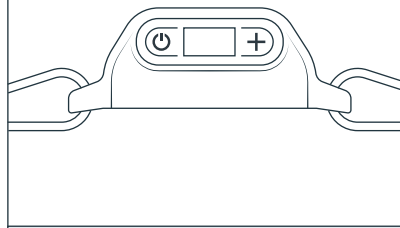

3 Buttons Up

Always wear the Tag with buttons facing upward.

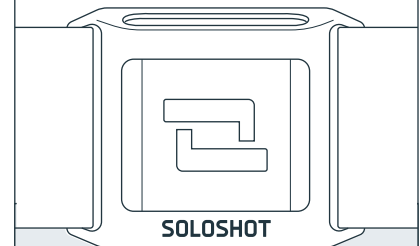

Using the Viewfinder

- 1 **Tag Manager**
Displays how many Tags are being tracked.
Tap to navigate to the Tag Manager.
- 2 **Track**
Start or stop tracking.
- 3 **Record**
Start or stop recording.
- 4 **LIVE**
Start or stop live streaming.
- 5 **Status Bar**
Displays Wi-Fi strength and battery level.
- 6 **Pulldown Menu**
Access the home screen, Wi-Fi, camera controls, and settings.
- 7 **SD Card Indicator**
Available SD Card Space and record time

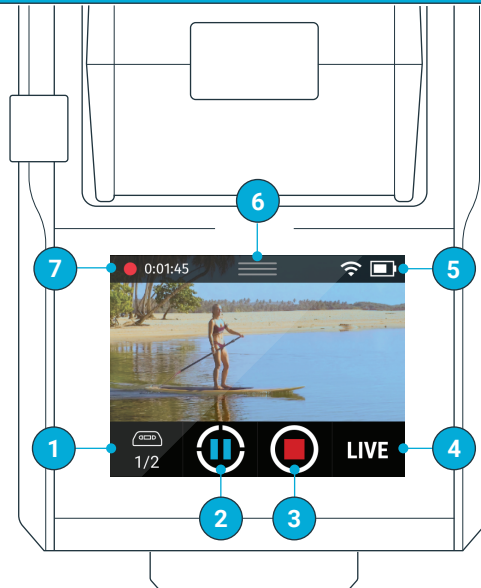

Pulldown Window

- 8 **SD Card Storage Space**
Displays how much recording time or number of photos remain.
- 9 **Home**
Exits the Track App, ends tracking/recording and takes you back to the Home Screen.
- 10 **Wi-Fi**
Opens WiFi settings.
- 11 **Refine**
Allows you to manually adjust the framing of the the subject in the viewfinder.
- 12 **Settings**
Opens the Settings window, allowing you to change camera mode and tracking settings.

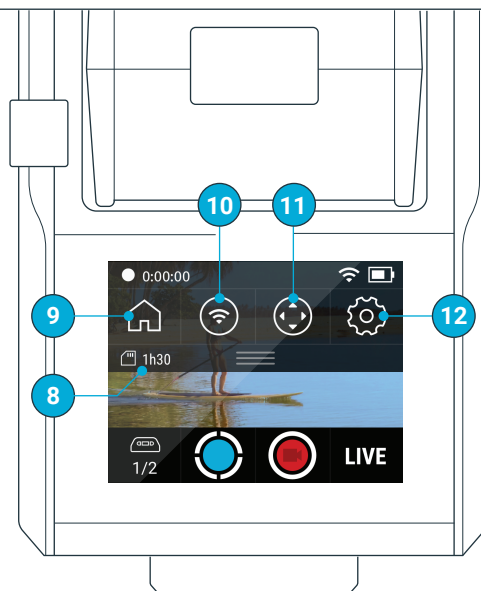

Using the Tag Screen

- 1 **Battery Level**
Displays the remaining battery level.
- 2 **Tracking Status**
Displays whether the TAG would like to be tracked.
- 3 **GPS Status**
Displays the status of the TAG's GPS signal.
- 4 **Record**
Displays if TAG would like to be recorded.

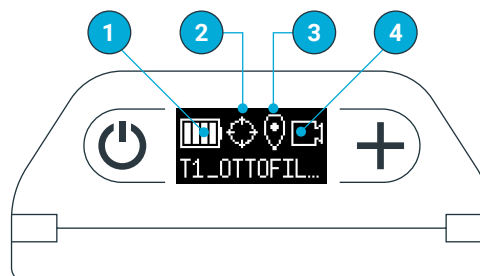

Pause and Resume Tracking



IMPORTANT

A good GPS signal is required for tracking.

Be sure to power-on the Tag and make sure it has a clear view of the sky before beginning your activity.

Good GPS Signal



Poor GPS Signal



1

From the Tag

Double tap the **+** button to pause or resume tracking.

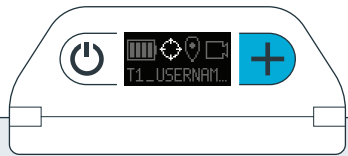

i

Tag: Track Icon

Tracking Paused

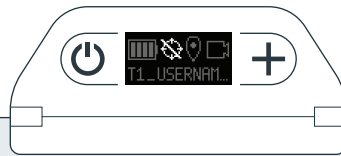

Tracking Active



2

From the Base

Tap the TRACK button to pause or resume tracking.

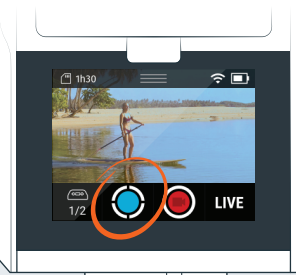

i

No Tags

The system is smart. If there are no other Tags to track, then the Base will automatically stop recording/tracking. Users can override this from the Base.

Start and Stop Recording

1

From the Tag

Press and hold the **+** button to toggle record on or off.

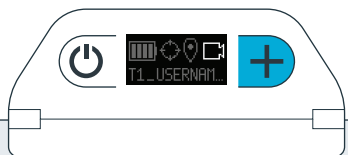

i

Tag: Record Icon

Recording Off

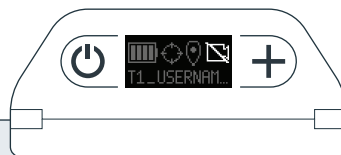

Recording On

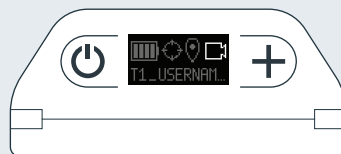

2

From the Base

Tap the RECORD button to start or stop recording.

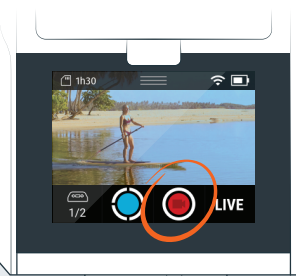

Start and Stop Live Streaming

! WARNING

All live streams are viewable to the public on the SOLOSHOTapp.

! REQUIREMENTS

- Connected to Wi-Fi.
- Internet Speed Requirements:
 - A minimum of 5 Mbps upload speed
 - Stream quality depends on the internet connection speed.
- Base is calibrated.

See page 8, CALIBRATING

- Regardless of recording resolution, the live stream video is compressed at 720p60.

1 LIVE

Tap the LIVE button.

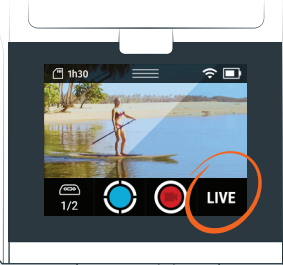

2 The LIVE Action Sheet

The live streaming action sheet allows you to begin live streaming or change live stream settings.

Tap GO LIVE or SETTINGS.

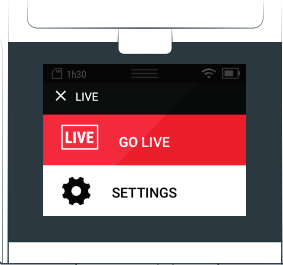

3 SETTINGS

If SETTINGS is selected:

Add a Title and Description to your stream. This information will appear on your stream in the SOLOSHOTapp.

If the **Title** is unchanged, it will default to "Live with #SOLOSHOT3"

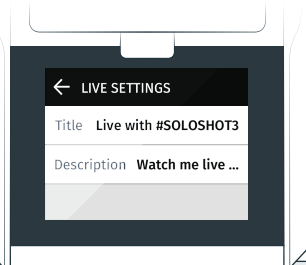

4 GO LIVE

Select GO LIVE.

The Base will attempt to connect to the SOLOSHOT network.

Live Stream Started

while live stream is active, the track app interface shows the LIVE highlighted in red.

Live Stream Failed

Check your internet connection and try again.

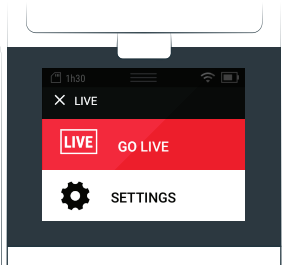

5 Ending a Live Stream

To stop live streaming, tap the LIVE button, then END LIVE.

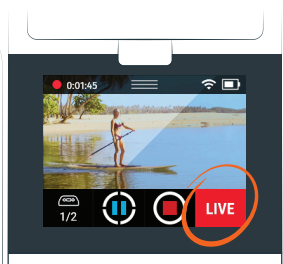

i The App | Terms & Conditions

Your live streams appear on the SOLOSHOTapp and app.soloshot.com. Be sure to download the SOLOSHOTapp on the App Store or Google Play!

By streaming, you agree to all terms and conditions including privacy as described at soloshot.com/terms.

Moving the Base

i **No Problem**

It is possible to reposition the Base at any time. Simply pick up the Base (and Tripod) and move it to a new location.

i **Re-Calibration**

If tracking is on
Picking up the Base will automatically pause tracking and recording.

Once stable, the Base will re-calibrate and resume tracking and/or recording

If tracking is paused
The Base will re-calibrate once the user resumes tracking.

i **NOTE**

Maintain location setup best practices.
See page 5, LOCATION SETUP

Tracking Distance

i **Minimum Distance**

The Base is optimized to track Tags at least 10 feet away. When tracking Tags inside a 10 foot radius, the Base may temporarily lose the subject.

i **Maximum Distance**

Up to 2,000 feet away. If Tags fall out of range, the Base will become idle, or track the next available tag in multi-mode.

Advanced Track Settings

Continue on next page

1 **From the Home Screen**

Many tracking settings are available to suit your filming preferences.

Tracking settings can be adjusted prior to calibration or any time during tracking/filming.

Open Track Settings by tapping the TRACK button.

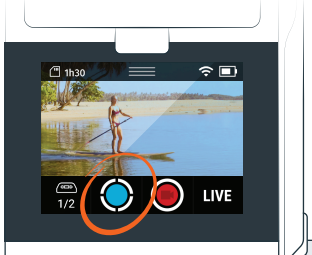

2 **Open Settings**

Select SETTINGS

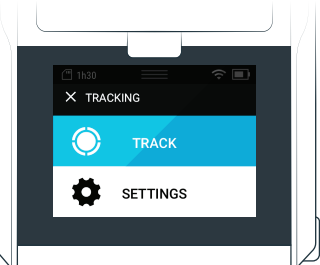

i **Default Settings**

Camera Mode: **Video**
Resolution: **1080p60 fps**
Framing: **Bottom Middle**
Field-of-View: **Medium**
Trajectory: **3 Seconds**

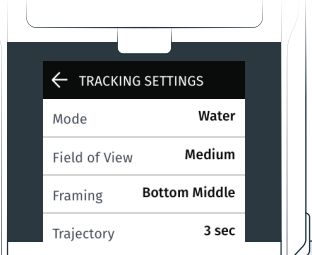

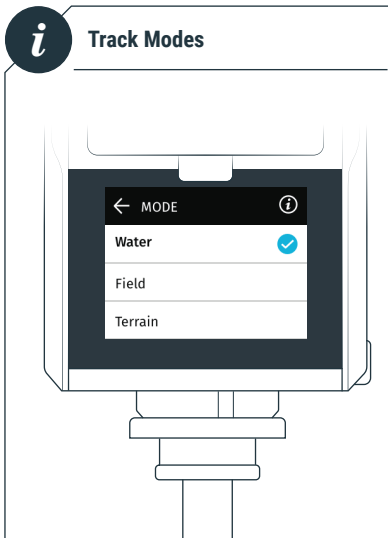

i

Track Modes



Water

For performing activities on the water.

Examples:

- Surfing
- Kiteboarding
- Sailing.



Field

For performing activities on a level playing field or gradual slopes.

Examples:

- Soccer
- Track & field
- Equestrian.



Terrain

For performing activities on uneven surfaces.

Examples:

- Skating
- Snowboarding
- Motocross



Flight

For performing aerial activities.

Examples:

- RC planes
- Drones (UAVs)
- Paragliding.

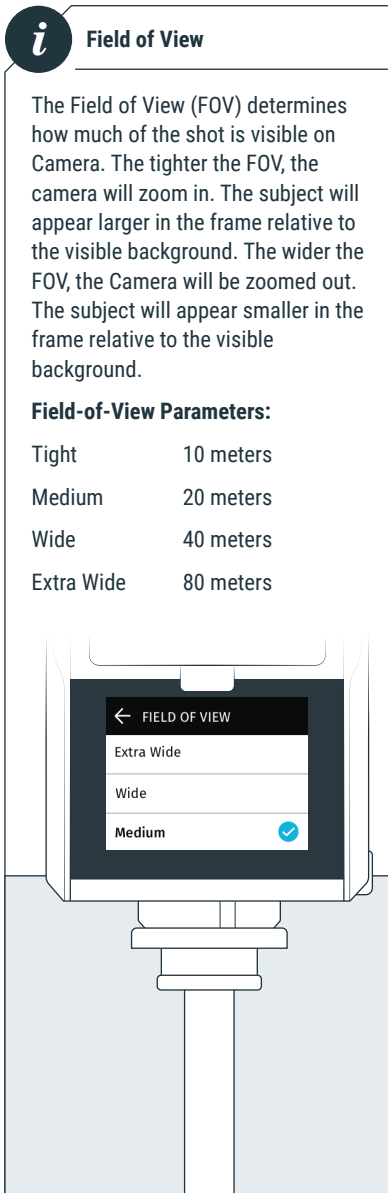

i

Field of View

The Field of View (FOV) determines how much of the shot is visible on Camera. The tighter the FOV, the camera will zoom in. The subject will appear larger in the frame relative to the visible background. The wider the FOV, the Camera will be zoomed out. The subject will appear smaller in the frame relative to the visible background.

Field-of-View Parameters:

Tight	10 meters
Medium	20 meters
Wide	40 meters
Extra Wide	80 meters

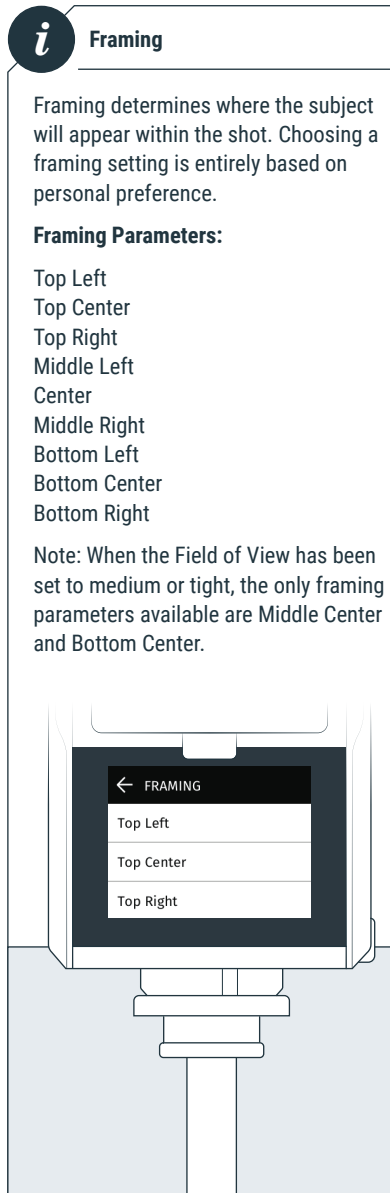

i

Framing

Framing determines where the subject will appear within the shot. Choosing a framing setting is entirely based on personal preference.

Framing Parameters:

- Top Left
- Top Center
- Top Right
- Middle Left
- Center
- Middle Right
- Bottom Left
- Bottom Center
- Bottom Right

Note: When the Field of View has been set to medium or tight, the only framing parameters available are Middle Center and Bottom Center.

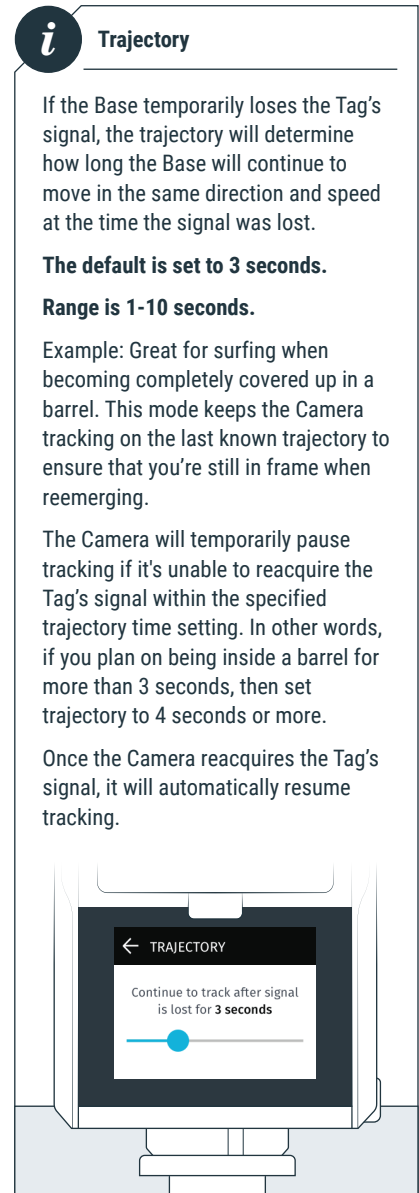

i

Trajectory

If the Base temporarily loses the Tag's signal, the trajectory will determine how long the Base will continue to move in the same direction and speed at the time the signal was lost.

The default is set to 3 seconds.

Range is 1-10 seconds.

Example: Great for surfing when becoming completely covered up in a barrel. This mode keeps the Camera tracking on the last known trajectory to ensure that you're still in frame when reemerging.

The Camera will temporarily pause tracking if it's unable to reacquire the Tag's signal within the specified trajectory time setting. In other words, if you plan on being inside a barrel for more than 3 seconds, then set trajectory to 4 seconds or more.

Once the Camera reacquires the Tag's signal, it will automatically resume tracking.



Camera Settings

Access Camera Settings

1 Viewfinder Pulldown

Tap the PULLDOWN MENU.

2 Settings Icon

Select SETTINGS.

3 Camera Settings

Select CAMERA SETTINGS.

! IMPORTANT

Tracking and recording stop when accessing **Camera Settings**.

Video Mode: Camera Settings

1 Changing the Resolution

Enter CAMERA SETTINGS (above).
Tap RESOLUTION to change the video resolution.

i Resolution Parameters

Optic65 Camera	Optic25 Camera
4k30	1080p30
1080p30	1080p60
1080p60	720p120
1080p120	

2 Select and Exit

Select desired resolution.
Tap the BACK ARROW to exit CAMERA SETTINGS.

i DEFAULT SETTINGS

The Camera is set to Video Mode with a resolution of 1080p60.

Photo Mode: Camera Settings

1 Selecting Photo Mode

Enter CAMERA SETTINGS (page 15).

Tap **Camera Mode**

Select **Photo**.

Tap the BACK ARROW to enter Photo Camera Settings.

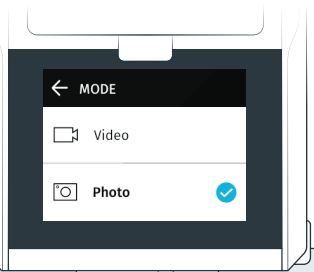

i Photo Mode: Camera Settings

Here, you can adjust the following:

Photo Mode

Single or Burst

Timer

The delay time between when you tell the Camera to take a photo(s) to when the shutter fires.

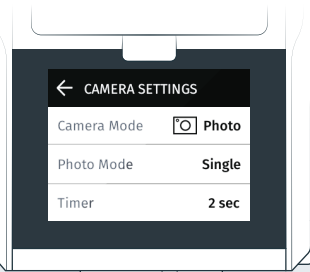

i Photo Burst

When **Burst** is selected, a new option is available.

Rate

This setting allows you to choose the number of consecutive photos to take over a period of time.

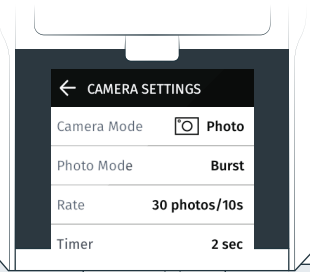

Taking Photos



Requirements

- In Photo Mode
- Must be Calibrated and Tracking.

1 From the Tag

Press the **+** Button on the Tag.

The Camera will take photos based on your selected settings.

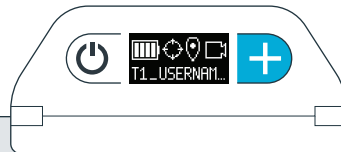

2 From the Base

Tap the SHUTTER/RECORD button.

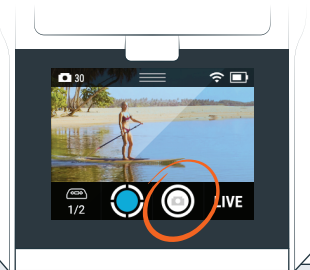



Multi-Mode

Follow Mode Settings

1 Select Tags

Enter the Tag Manager from either the Home Screen or the Track App.
Select which Tags you want to follow.

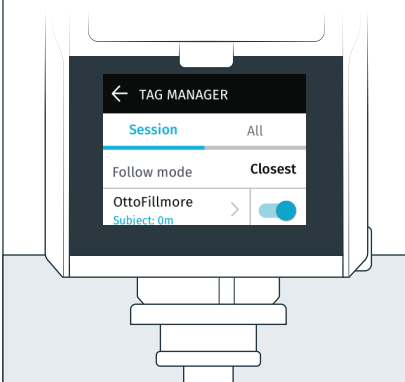

Requirements

- At least two (2) Tags and/or Bases must be turned on and Tracking.

Purchase additional products at soloshot.com.

2 Select Follow Mode

On each Base, choose between three (3) settings that instructs your Base which Tag to follow.

Each Base being used to follow multiple Tags or the same Tag can be configured differently.

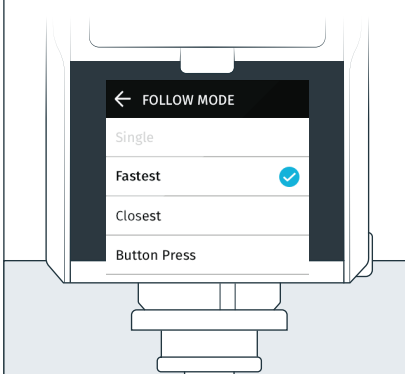

Settings Descriptions

Closest

The Base will track the closest Tag.

Fastest

The Base will track the fastest moving Tag.

Button Press

Tapping the **+** button on the Tag will trigger all Bases on the Button Press setting to begin tracking that Tag. The Base will continue to track this Tag until another Tag performs the button press.

Filming Scenarios: Multiple Tags from a single Base



Requirements

- The Tags that you'd like to track in the session must be saved to the Base.

1 Select Tags

Enter the TAG MANAGER.
Toggle tracking on for **all Tags** that you would like to track.

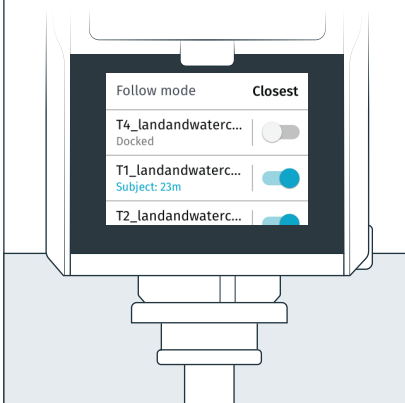

2 Follow Mode

Select FOLLOW MODE.
Exit the TAG MANAGER by tapping the BACK ARROW.
Calibrate your Base and begin Tracking.

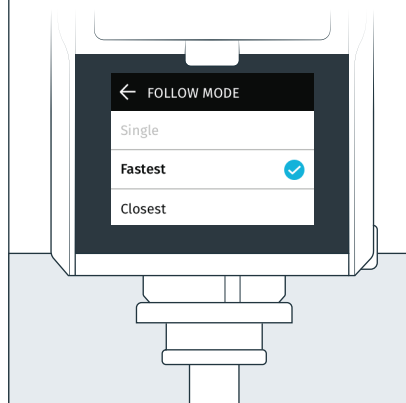

Filming Scenarios: Single Tag from multiple Base



Requirements

- The Tag that you'd like to track in the session must be saved to all Bases being used.



1 Select Tag

Enter the TAG MANAGER.

On all Bases being used, toggle tracking on for the Tag that you would like to track.



2 Follow Mode

Follow Mode does not apply here as there is only one Tag in the system.

Exit the TAG MANAGER by tapping the BACK ARROW.

Calibrate your Base and begin Tracking.

Filming Scenarios: Multiple Tags from multiple Bases



Requirements

- The Tags that you'd like to track in the session must be saved to all Base.



1 Select Tags

Enter the TAG MANAGER.

On all Bases being used, Toggle tracking on for **all Tags** that you would like to track.

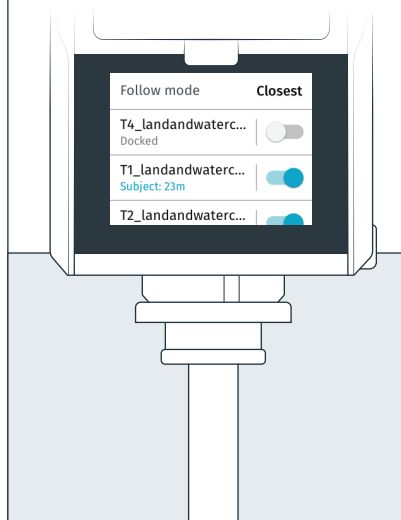

2 Follow Mode

Select FOLLOW MODE.

Follow Modes can be different on each Base.

Exit the TAG MANAGER by tapping the BACK ARROW.

Calibrate your Base and begin Tracking.

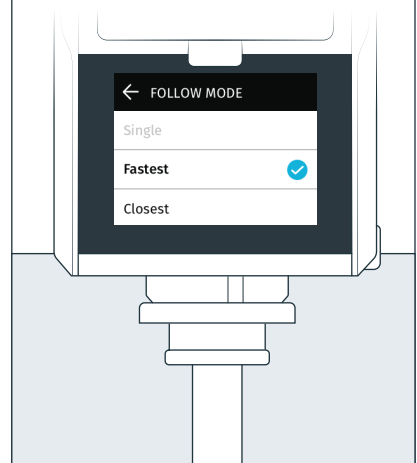



Motion Time-Lapse

Setting MTL Parameters

1 Overview + Open Settings

Motion Time Lapse is the ability to capture a series of photos at while moving at predetermined intervals.

From the Home Screen, tap the Dropdown Menu, then Settings.

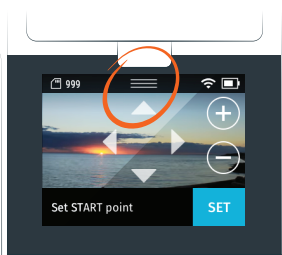

2 Modify Settings

Modify **Interval** and **Number of Frames** to create your desired result. **Elapsed Time** will automatically calculate.

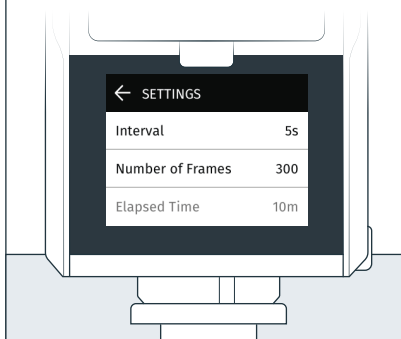

! TIP

Use a shorter interval [1-3 seconds] when capturing faster moving objects.

Use a longer interval [5 seconds or more] when capturing slower moving objects

i Settings

Interval

The number of seconds that will elapse between each photo.

Interval Parameters:
3s, 5s, 10s, 30s, 60s

Number of Frames

The number of photos that will be taken in the session.

Number of Frames Parameters:
10, 100, 300, 450, 900, 1800

Elapsed Time

The total time it takes to perform the motion time lapse. It is calculated by multiplying the interval by number of frames, and is displayed in total minutes.

Setting Start and End Points

1 Set Start Point

Use the arrows to find a **START** point and adjust the field of view (degree of zoom).

Tap **SET**.

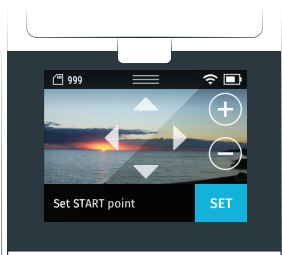

2 Set End Point

Use the arrows to select the **END** point (zoom is disabled at this stage).

When finished, tap **START** to begin.

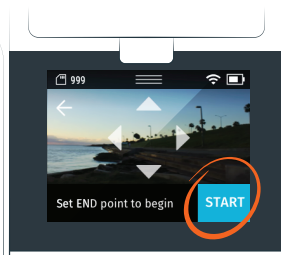



Manual App

i

Home Screen

Within the HOME SCREEN, tap **MANUAL CONTROL** to enter the Manual Control App.

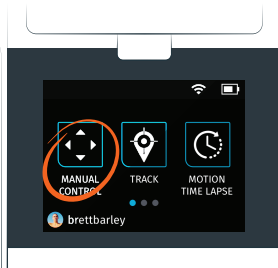

2

Pan, Tilt and Zoom

Adjust the camera's framing by tapping on the pan, tilt, and zoom (in/out) controls.

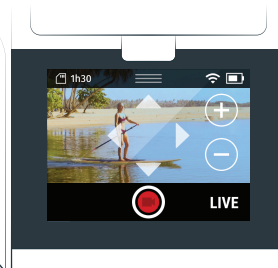

2

Preview the Frame

Tap anywhere else on the viewfinder to hide the controls and the status bar.

You can also hide only the controls via the dropdown menu (below).

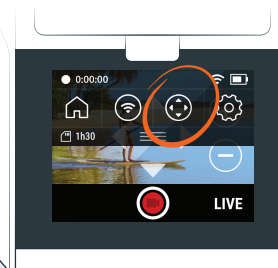

3

Begin Recording

Tap the **RECORD** button to start recording. Tap the button again to stop recording.

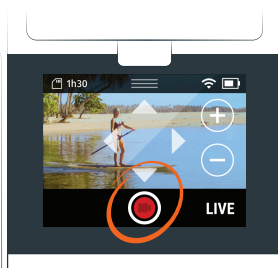

4

Start and Stop Live Streaming

Tap the **LIVE** button.

See page 12, LIVE STREAMING

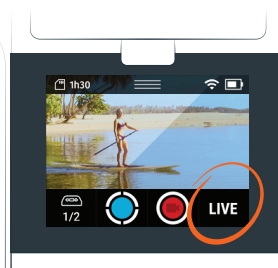

5

Camera Settings and Photos

Camera Settings

See page 15, CAMERA SETTINGS

Taking Photos

See page 16, TAKING PHOTOS

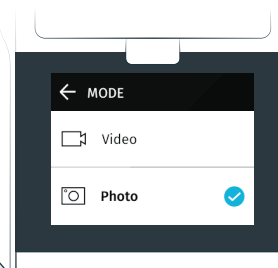



Update App

i

Overview

SOLOSHOT3 and its components will continually improve over time with frequent software updates.

Updates contain performance improvements, new features, and bug fixes just like software updates on your smartphone or computer.

2

Check For Updates

In the home screen, select the UPDATE APP.

The system will automatically check for available update.

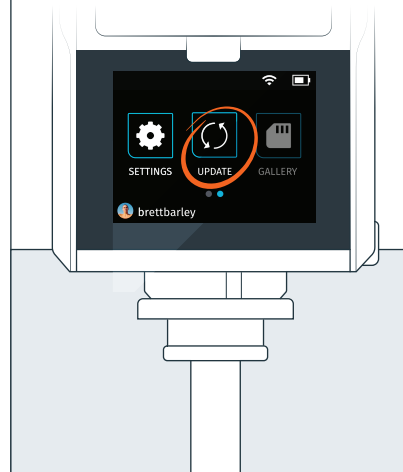

2

Updating

If an update is available, you can view the change log and/or begin the update by tapping "Update." Follow the on-screen instructions to update the Base, Tag, and Camera.

If no updates are available, then tap DONE to return to the home screen.



Tag Update Mode

1

Power Off

The Tag must be placed in Update mode before updating the software.

Power off the Tag by holding down the Power button for 2 seconds, until the screen turns off.

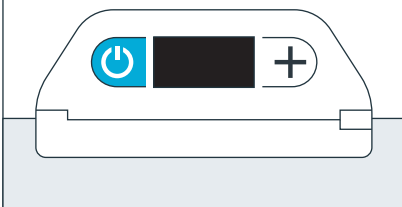

2

Power On In Update Mode

While holding down the **+** button, press the power button.

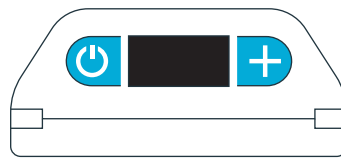

The Tag will turn on and the OLED will display a graphic indicating that it needs to be docked to the Base.

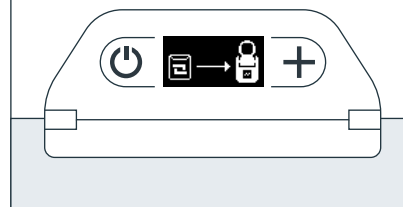

3

Dock the Tag

Dock the Tag into the accessory port on the front of the Base.

Follow the onscreen instructions and continue with the update process.

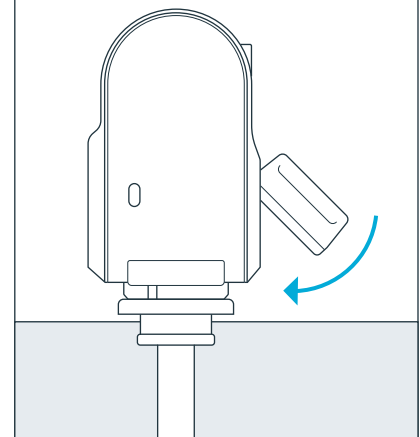



Settings

1 Open Settings

From Home Screen, Tap SETTINGS

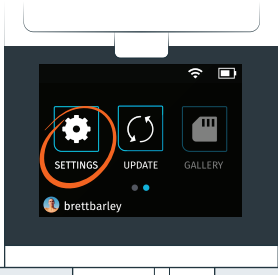

2 Settings List

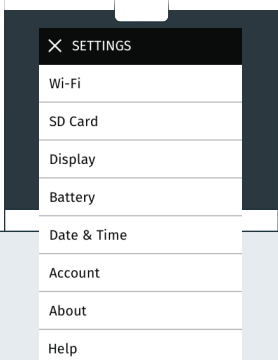

i Settings Descriptions

Wi-Fi
Wi-Fi network is required to perform software updates and to live stream.

Supported Networks
2.4 GHz

Non-supported Networks
5.0 GHz, Captive portals

SD Card
View capacity and format your SD card. Remaining storage is calculated based on the currently selected recording resolution in the TRACK APP.

Recommended
Format your SD card the first time, before use.
• Settings > SD Card > Format

Use only approved SD Cards available through authorized sellers. For a complete list of approved SD Cards visit soloshot.com/sd-card

Display
Adjust the screen brightness and sleep timer.

Battery
View the charging status and current battery level.

Date & Time
Set the date & time, and time zone.

Recommended
Set automatically

Account
Within the Account app, view the name and details associated with your Base(s). Creating an account is part of the process when using a new Base for the first time. Go to app.soloshot.com to create an account.

Base Name
Your first Base registered with your account will be listed as B1_username.
• If you register a second Base, it will be listed at B2_username, and so on.
• You can register an unlimited number of Bases to your account.

Base Details
View detailed information and to unregister your Base from the current account.
• Unregistering your Base is helpful when logging into a new or different account.
• For security reasons, your account password must be entered to successfully unregister.

About
View software, legal, and regulatory information.

Help
Visit support.soloshot.com

Developer Options
Not for general use.

HDMI Out

i **Overview**

Provides output and Video Playback for TVs and Monitors.

Micro HDMI cable is required.

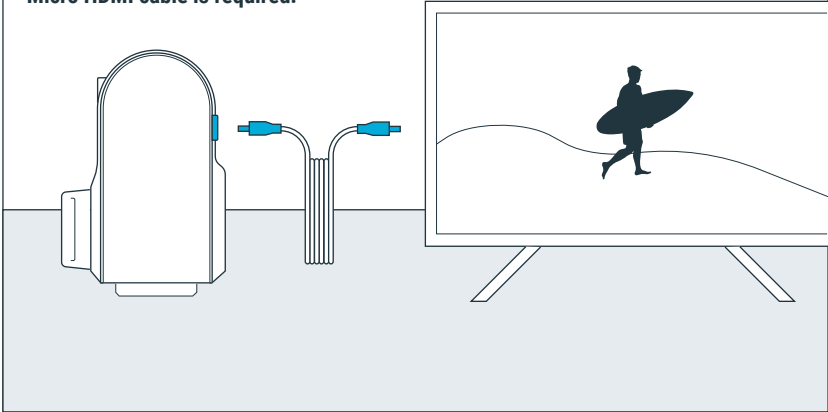

i **Information**

The Base outputs uncompressed video from the Optic65 and Optic25 Cameras at 720p60.

HDMI out is available anytime Camera Preview is available on the Base.

The color space of the HDMI output is RGB.

! **WARNING**

To avoid damage, remove all cables prior to and during calibration as the Base spins.

Audio and Hot Shoe Mount

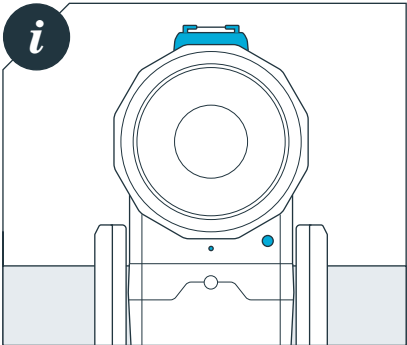

i **Audio**

Audio Compression: AAC 48KHz (128Kbit/s)

Internal Mic: Mono, Digital

External Mic: Analog, Stereo (3.5mm)

Remote Wireless Mic: Supported (sold separately)

i **Hot Shoe**

The hot shoe can be used to mount an external mic and will accommodate future SOLOSHOT accessories.

Maintenance

i **Care**

The Base contains many electrical and mechanical parts and must be cared for to prolong life.

As a general rule of thumb, here are do's and don'ts.

! **DO NOT...**

- ... **submerge the Base and Camera underwater.** They are not water resistant.
- ... **stick any foreign objects between the tilt and main structure of the Base.**
- ... **manually pull the lens out of the camera.** Attempting to do so will damage the motors.
- ... **manually force the Base to tilt or pan.**
- ... **attempt to open the Base to troubleshoot.** This will void your warranty.
- ... **keep cables plugged in during device calibration.**

! **DO...**

- ... clean the Base by lightly wiping with a damp cloth.
- ... remove the Base from the tripod after each use.
- ... consistently update to the latest software to optimize the Base.
- ... rinse your Tag and armband in fresh water after contact with saltwater.
- ... clean the lens with a microfiber cleaning cloth.



Offloading Content

1

Ejecting the MicroSD Card

Push the MicroSD card to eject it from the SD card port.

Carefully remove the MicroSD Card.

Do Not use sharp/metal tools to remove the card. This may damage the MicroSD Card port.

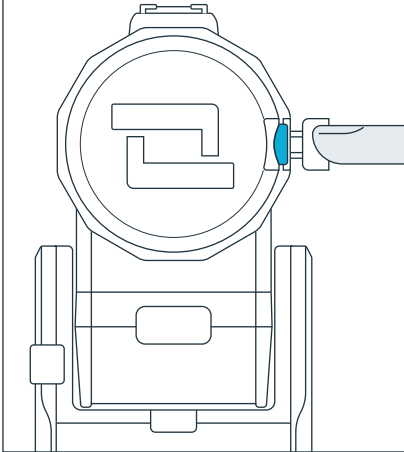

2

SD Card Reader and Adapter

Insert the MicroSD card into a SD card reader. If your computer does not have a built-in reader, an external reader will be needed.

A MicroSD Card Adapter, below, may be needed. This is usually included with the MicroSD Card.

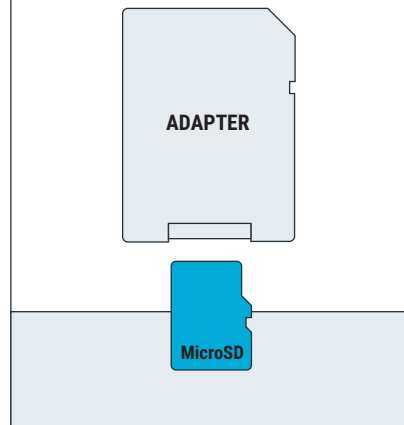

3

Moving DCIM Folder

Move the DCIM folder or select files from within the folder onto your computer.

